

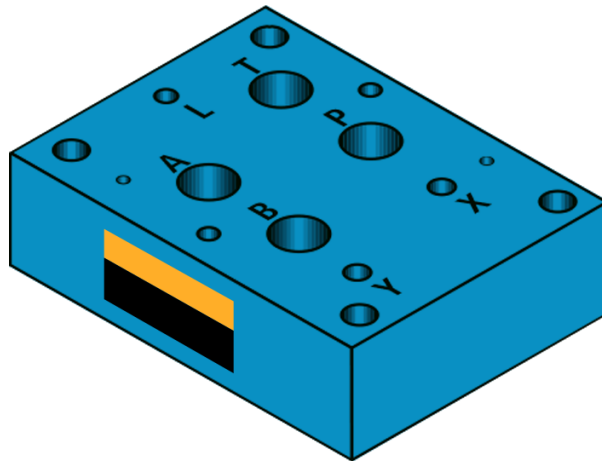

SANDWICH PLATE

MODEL Z1S16



WWW.OLEDDINAMICAMOZIONI.IT

Z1S16 INTRODUCTION

CHECK VALVES OF SANDWICH PLATE DESIGN ARE INTENDED FOR MATING WITH CONTROL VALVES. THEY ALLOW FREE FLOW OF FLUID IN ONE DIRECTION AND SELF-ACTING CLOSURE IN THE OPPOSITE DIRECTION. VALVES CAN BE MOUNTED IN ANY POSITION AS AN INTERMEDIATE ELEMENT BETWEEN A SUBPLATE AND A CONTROL VALVE.

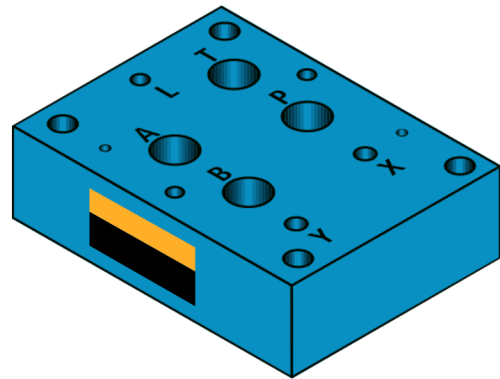

Z1S16 TECHNICAL DATA

HYDRAULIC FLUID	MINERAL OIL OR PHOSPHATE ESTER
NOMINAL FLUID VISCOSITY	37 MM ² /S AT THE TEMPERATURE OF 55°C
VISCOSITY RANGE	2.8 TO 380 MM ² /S
REQUIRED FLUID FILTRATION	16 μM
RECOMMENDED FLUID FILTRATION	10 μM
MAXIMUM WORKING PRESSURE	32 MPa
CRACKING PRESSURE	0.05 MPa
MAXIMUM FLOW RATE	200 L/MIN
WEIGHT	3.7 KG

Z1S16 SCHEMES

VALVE SIDE

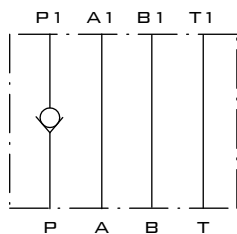

Z1S16 P

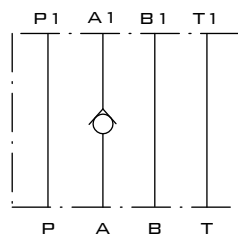

Z1S16 C

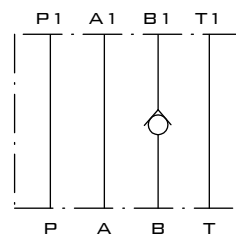

Z1S16 D

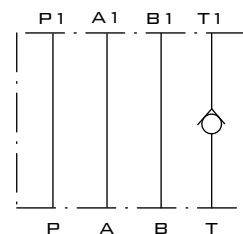

Z1S16 T

SUBPLATE SIDE

Z1S16 DESCRIPTION OF OPERATION

Z1S16P-1-30

VALVE SIDE

THE SLEEVE 3 WITH THE SEAT FOR THE SPRING 4 IS FITTED IN THE HOUSING 1. THE SPRING PUSHES THE POPPET 2 TO THE EDGE OF PORT P IN THE HOUSING 1. WHEN PRESSURE DIFFERENCE IN PORT P EXCEEDS THE CRACKING PRESSURE DETERMINED BY THE SPRING, THE POPPET WILL MOVE ALLOWING FREE FLOW IN LINE P, A, B, T OR A AND B.

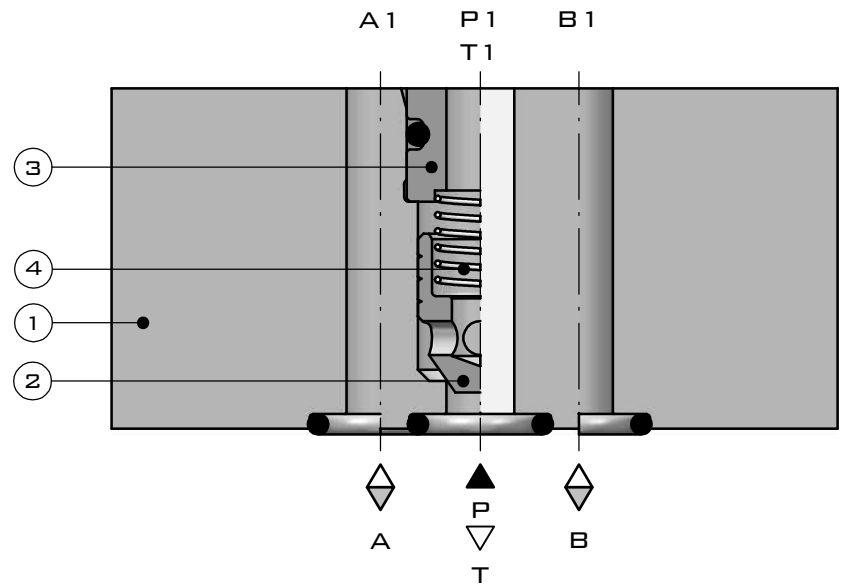

SUBPLATE SIDE

Z1S16 PERFORMANCE CURVES

MEASURED AT $v = 41 \text{ mm}^2/\text{s}$ AND $T = 50^\circ\text{C}$

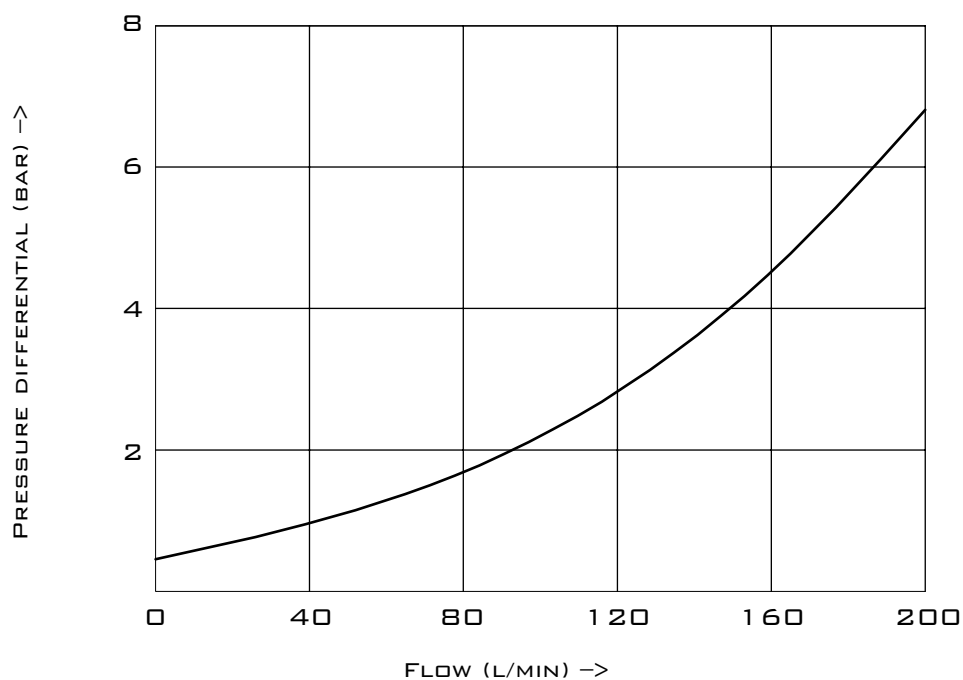

Z1S16 OVERALL DIMENSIONS

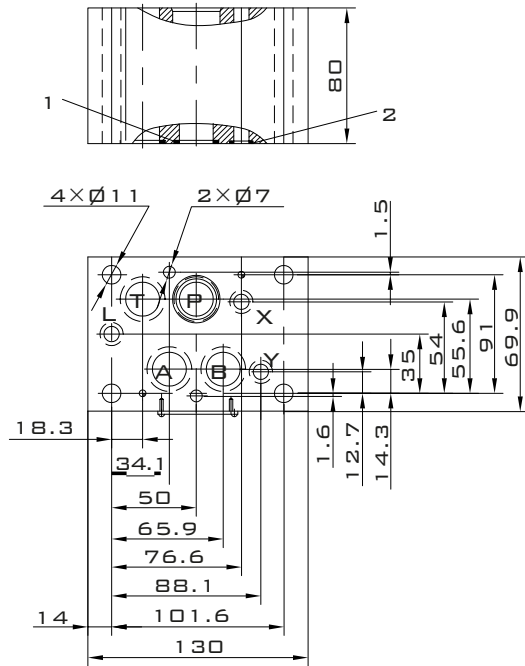

- 1 O-RINGS 22X2.5 (PORTS A, B, P, T)
- 2 O-RINGS 10X2 (PORTS X, Y, L)

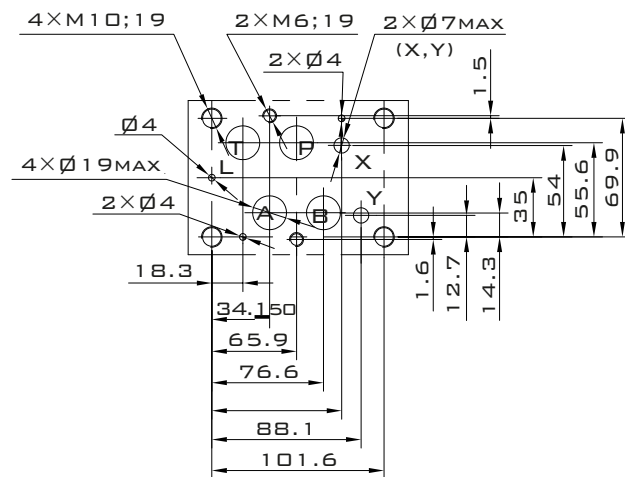

0.01/100MM

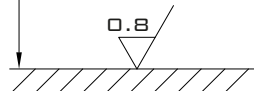

REQUIREMENT FOR MOUNTING SURFACE



Z1S16

SANDWICH PLATE

ORDER CODE

Z1S16 - [] [] [] [] *

CHECK VALVE

PORT P = P
PORT A = C
PORT B = D
PORT T = T

1 = CRACK PRESSURE 0.5 BAR
2 = CRACK PRESSURE 3 BAR
3 = CRACK PRESSURE 5 BAR

ADDITIONAL REQUIREMENTS IN CLEAR TEXT
(TO BE AGREED WITH THE MANUFACTURER)

SEALING

FLUIDS ON MINERAL OIL BASE = NO DESIGNATION

FLUIDS ON PHOSPHATE ESTER BASE = V

30 =

30 SERIES